

BMDW4.8-32

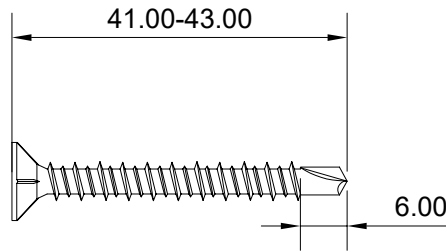

BMDW4.8-42

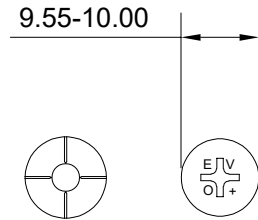
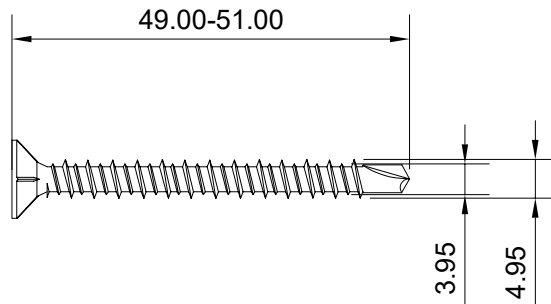
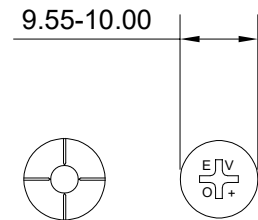

BMDW4.8-50

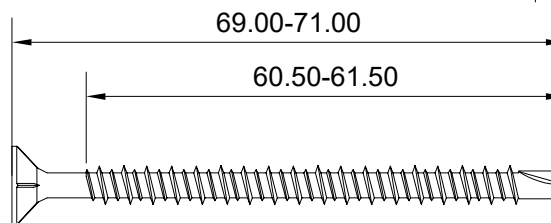
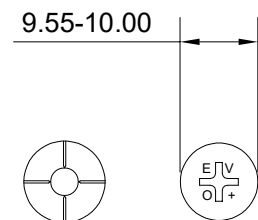

BMDW4.8-70

**NOTE:**

1. All dimensions in millimeters unless otherwise noted, do not scale. Structural sections to be designed by others. Evolution fasteners specified in accordance with material loads provided by project specific Engineer. Evolution fasteners must be installed as per best practice or manufacturers guidelines.
2. Due to the nature of the product, this drawing is provided strictly without prejudice, without recourse, without liability, non-assumpsit, no assured value, errors and omissions excepted, subject to change without notice and all rights reserved. This drawing remains the intellectual property of Evolution Fasteners UK Ltd and must not be copied, altered or reproduced without the expressed, written approval of Evolution Fasteners UK Ltd. This drawing supersedes all previous versions and is subject to change without notice, as such dimensions may not match historical stock or product.

		DESCRIPTION	SHEET-	ISSUE-
		BMDW Range	01	C
THREAD AND HEAD MATERIAL GRADE		DRILLING POINT MATERIAL GRADE		
SAE 304		SAE C1022		
COATING				
Electroplated zinc				